

# Keysight N1055A

Remote Head Module

35/50 GHz 2/4 Port TDR/TDT

For the 86100D DCA-X Series Oscilloscope Mainframe

Data Sheet



Engineered for easy, accurate impedance and S-parameter measurements on multi-port 10/25/28 Gbps (40 Gb/100 Gb) designs

- Highest resolution TDR/TDT measurements
- Fast and accurate multiport S-parameters, up to 16 ports
- World's easiest-to-use solution

## Signal Integrity Challenges Abound

As new digital designs increase in data rates to 28 Gb/s and beyond, signal integrity issues become more challenging. Additionally, industry standards such as IEEE 802.3 ba/bj/bm (40 Gb/100 Gb Ethernet), Optical Inter-networking Forum (OIF) CEI 3.0, Fibre channel, PCI Express, USB, and InfiniBand require the use of TDR/TDT and S-parameter measurements to ensure compliance and system interoperability.

### A fully-integrated 86100D TDR/TDT/S-parameter measurement system

Designed for both novice and expert users alike, the Keysight Technologies, Inc. N1055A remote head module provides time-domain reflectometry and transmission (TDR/TDT) capability for the 86100D DCA-X oscilloscope platform, providing fast and accurate impedance and S-parameter measurements on high-speed designs that have up to 16 ports. The 86100D DCA-X oscilloscope mainframe can be configured with one to four N1055A TDR/TDT plug-in modules to provide a 2- to 16-channel TDR/TDT measurement system that is both economical and accurate. The 2/4 port TDR/TDT remote heads can be configured with sampler bandwidth of 35 GHz or 50 GHz, providing single-ended and differential measurement capability including True-Mode stimulus functionality.



2- to 16-channel TDR/TDT/S-parameter measurement system.

### Measurements include:

#### Time-Domain Reflectometry (TDR)

- Impedance measurements
- Locate the position and nature of each discontinuity
- Propagation/time delay
- Excess reactance (capacitance or inductance)
- Effective dielectric constant

#### Time-Domain Transmission (TDT)

- Step response
- Propagation/time delay
- Propagation velocity
- Rise-time degradation
- Near-end crosstalk (NEXT)
- Far-end crosstalk (FEXT)
- Skew

#### S-parameters (86100D-202)

- Return loss
- Insertion loss
- Crosstalk
- Mode conversion
  - Differential-to common-mode conversion (SCDxx)
  - Common-to differential-mode conversion (SDCxx)
- Phase
- Group delay

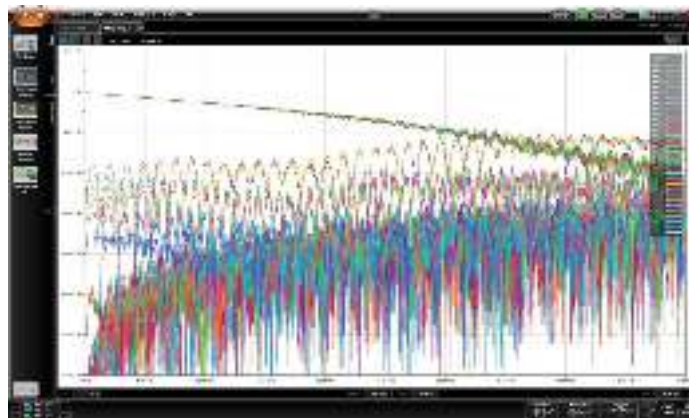

Fast and accurate S-parameter measurements.

The 86100D DCA-X mainframe, equipped with N1055A modules, creates a fully-integrated TDR/TDT/S-parameter measurement system that provides calibrated results on up to 16 channels in real-time

### Single-ended and differential device testing

Each TDR/TDT module provides single-ended, differential and common mode measurement capability, including True-Mode stimulus capability.

### Complete S-parameter analysis

Full S-parameter measurements from DC to 50 GHz on up to 16 ports. Export data in Touchstone file format.

### Real-time results

Calibrated impedance and S-parameter results are displayed in real-time (no external application, monitor or computer required).

### ECal DC - 67 GHz module support

Electronic calibration (ECal) modules provide fast and accurate calibrations with a minimum number of connections.

### True SOLT TDR calibration made easy

TDR/TDT calibration improves measurement accuracy. A built-in calibration wizard supports both mechanical standards (SOLT) and ECal modules.

### Fast TDR edge speed

Fast edge speeds yield higher TDR resolution.





## Built-in ESD/EOS protection

Each remote head integrates 67-GHz diode limiters to help protect against electrostatic discharge (ESD) and electrical overstress (EOS).

## Adjustable edge speed

After TDR calibration the effective TDR edge speed may be adjusted (faster or slower) to comply with standards-based testing.

## N1055A bandwidth options

- 35 GHz <sup>1</sup>
- 50 GHz

## N1055A channel count options

- 2 channels per module <sup>2</sup>
- 4 channels per module

## High-bandwidth oscilloscope

The N1055A's receiver can be used as an oscilloscope to analyze waveforms and perform precision jitter analysis (86100D-200) on high-speed data signals.

## Up to 16 channels per mainframe

Up to 16 TDR/TDT channels per 86100D DCA-X mainframe minimize cable reconnections and facilitate efficient near-end crosstalk (NEXT) and far-end crosstalk (FEXT) measurements.

## Connector flexibility maximizes signal integrity:

Choose male or female connectors to minimize the need for adapters and cables, which improves signal integrity and saves money.

- 50 GHz modules: 1.85 mm male or female connectors
- 35 GHz modules: 2.92 mm male or female connectors

Note: All remote heads within a module must be configured with the same connector type.

1. Upgradable to 50 GHz  
2. Upgradable to 4 channel

## Highest Resolution TDR/TDT Measurements

High TDR resolution is essential for accurately characterizing complex high-speed structures. With TDR step 10-90 rise time as fast as 6 ps and receiver bandwidths of 50 GHz, the DCA-TDR solution resolves the magnitude and location of impedance discontinuities with unmatched performance.



The flexible, upgradable design offers 2- and 4-channel remote head modules.

### The importance of TDR edge speed

TDR resolution is determined by the rise time of the TDR step generator, the bandwidth of the receiver and the effective dielectric constant of the device under test (DUT).

The edge speed that is delivered to the DUT is called the transmitted edge speed. It is measured at the output of the remote head by a high-bandwidth receiver.

### 10 to 90% edge speed (raw hardware performance):

- 35 GHz option: < 18 ps
- 50 GHz option: < 7 ps
- See specification table for details

### 10 to 90% edge speed (with TDR calibration):

- 35 GHz option: 15 ps, characteristic
- 50 GHz option: 6 ps, characteristic
- See specification table for details

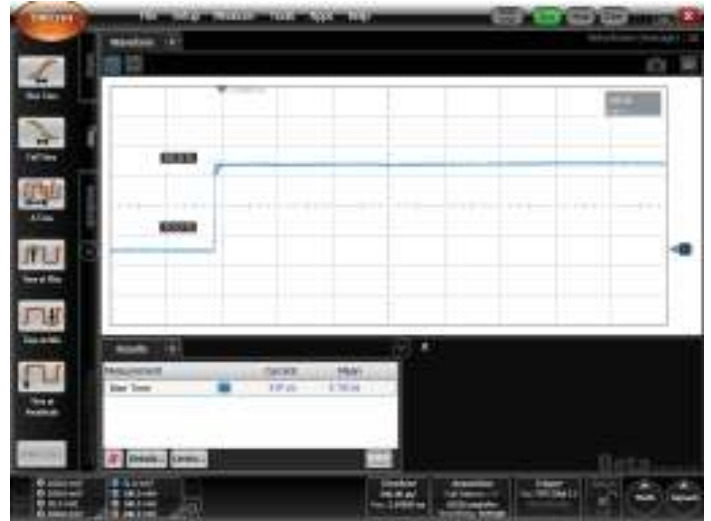

The ultra-fast TDR step generator (raw hardware step shown above) provides industry-leading TDR resolution.

### Upgradable to protect your investment:

Bandwidth upgrades:

Upgrade a 35 GHz module to 50 GHz by ordering the appropriate N1055AU option.

Channel count upgrades:

Upgrade 2 channels to 4 channels by ordering the appropriate N1055AU option.

All upgrades require returning the N1055A to Keysight Technologies.

## Adjustable effective TDR rise time

Standards typically specify 10 to 90% or 20 to 80% edge speeds to be used for compliant measurements. FlexDCA makes it easy to control the effective rise time of the stimulus pulse so users can perform compliant measurements.

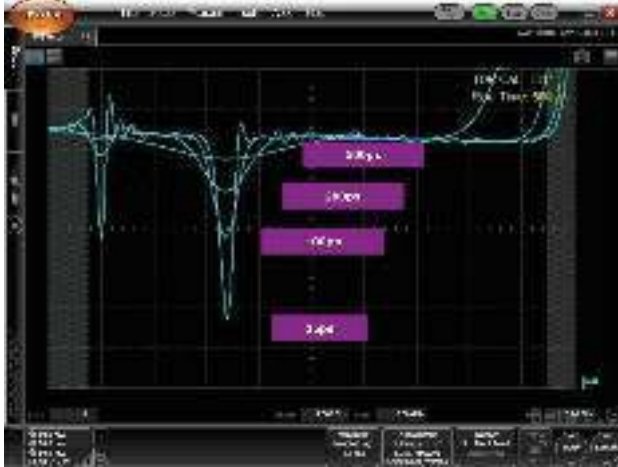

Adjustable effective TDR rise time ensures compliant measurements.

## Single-ended and differential stimulus



The TDR/TDT remote heads may be configured for single-ended, differential or common-mode measurements with True-Mode or Mixed-Mode stimulus.

Step polarity, skew, amplitude and repetition rate can also be configured.

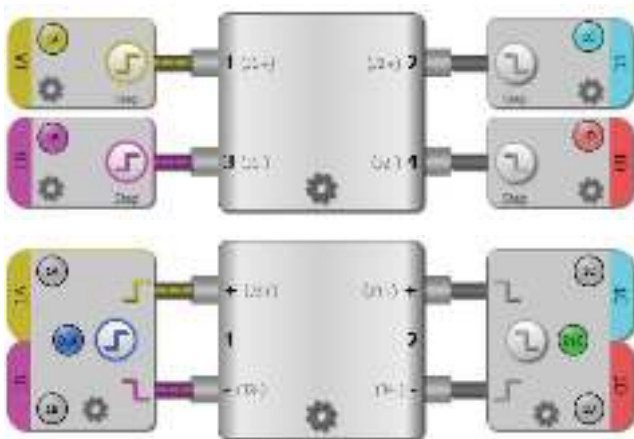

An easy-to-use graphical user interface simplifies single-ended and differential device setup.

## Ultra-slim remote heads optimize signal fidelity

The industry's lightest and smallest remote TDR heads allow direct connection to the device under test using a TDR/TDT step generator and low-noise sampler located at the end of a flexible 1.6-meter phase-stable cable. This ensures optimal step fidelity and minimizes signal degradation due to adapters or cables. Remote heads can be configured with male or female connectors to further minimize the number of adapters used in the system.



The industry's smallest TDR/TDT remote heads optimize signal fidelity.

Two remote heads form a differential pair; heads may be held together using a remote head clamp (two clamps are shipped with each module). When clamped, pin-to-pin spacing is 10 mm.

The ultra-thin remote head has also been designed so it can be directly connected to most high-bandwidth TDR probes on the market today, thereby minimizing signal degradation due to cables.



Ultra-thin remote heads connect directly to TDR probes or may be clamped together to form a differential pair (clamp included).

## TDR Fixture De-Embedding

Standard in FlexDCA software revision A.05.30.xx and newer, TDR fixture de-embedding enables you to remove the effects of fixtures, cables or probes connected between the remote heads and DUT. All you need is the S-parameter file for the device you want to de-embed. Flex DCA supports both 2-port and 4-port fixtures, and you can use multiple fixtures on DUTs up to 16 ports (fixtures cannot be connected together in series).

Using the same fixture, cable or probe on both the input and output of your DUT? FlexDCA makes it simple to reverse a fixture connected to any DUT port in the de-embed setup.



With FlexDCA, it is simple to re-assign the port order of the fixtures to de-embed, making it easy for you to use an S-parameter file created on any instrument.

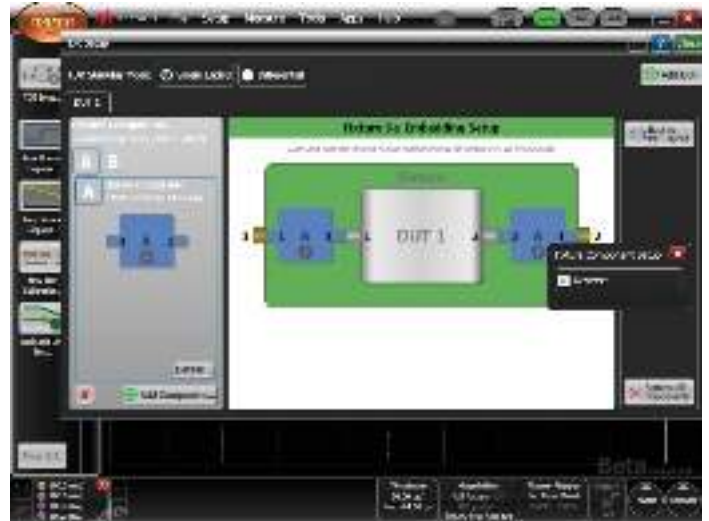
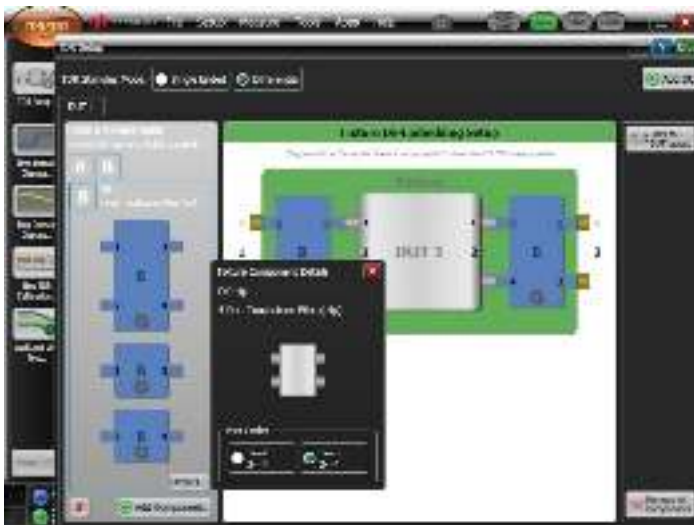

## Automatic Fixture Removal (AFR)

When measuring physical layer devices with non-coaxial interfaces, test fixtures or probes are often used to connect the device under test (DUT) to the measurement equipment. For accurate measurements of the DUT, the fixtures or probes need to be characterized and their effects removed from the composite measurement of the DUT plus test fixture or probe combination.

Modern TDR and VNA instruments have built-in de-embedding capabilities that enable the user to remove the effects of fixtures and probes from the measurement. Those de-embedding capabilities depend on the user having accurate characterization data, typically a touchstone file, for the fixture or probe to be de-embedded.

Since these fixtures or probes typically have non-coaxial interfaces on some ports, it is difficult to measure them directly.

### Historical method for characterizing fixtures and probes

Historically, one of the following methods have been used to characterize a fixture or probe:

- For probes, a calibration substrate – if available – rather than mechanical standards or an ECal module, is used to calibrate the TDR or VNA at the probe tips. This is often a challenge at higher frequencies
- For fixtures, one of two methods have been used:
  - Model the fixture using EM simulation
  - Use through-reflect-load (TRL) calibration

### New method for characterizing fixtures and probes: Automatic fixture removal

Based on simple calibration standards, time domain gating and signal flow calculations, automatic fixture removal (AFR) can be used to characterize fixtures and probes where a direct measurement is not possible. This approach is much simpler than TRL but has similar accuracy. The full suite of AFR capabilities, in addition to in-depth analysis capability, are included with the Keysight Technologies, Inc. Physical Layer Test System (PLTS) software, N1930B. The following AFR capabilities from PLTS are also available directly on the 86100D:

- One-port AFR
- 2x thru AFR

The details about all of the N1930B Physical Layer Test System software capabilities are available on the Keysight Web site: [www.keysight.com/find/PLTS](http://www.keysight.com/find/PLTS)

### One-port AFR

Many of the fixtures and probes used today have connectors on one port and non-coaxial interfaces on the other port, making them perfect candidates for characterization using one-port AFR.

One-port AFR requires the user to measure the probe or fixture from the connectorized port with the other port open and/or shorted. AFR then mathematically extracts the fixture or probe S-parameters from the open or short measurement (or both). That S-parameter file can then be used to de-embed the fixture using the standard TDR or VNA instrument de-embedding capabilities.

## Three Steps for High-Accuracy Probe/Fixture Characterization

1. Characterize the fixture or probe from the connectorized port(s)

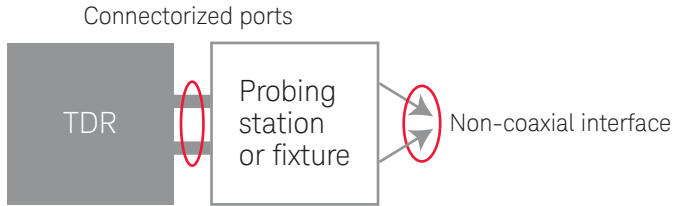

Measure the probe/fixture with the non-coaxial interface open and/or connected to a short = fixture.s2p

3. Measure the DUT with the probe or fixture and use the TDR de-embedding feature to remove the effects of the probe or fixture.s4p

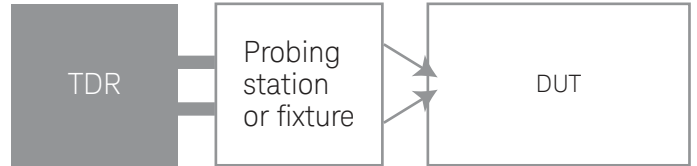

2. Use one-port AFR to extract the full characterization data for the fixture or probe



## Using the One-port AFR Software

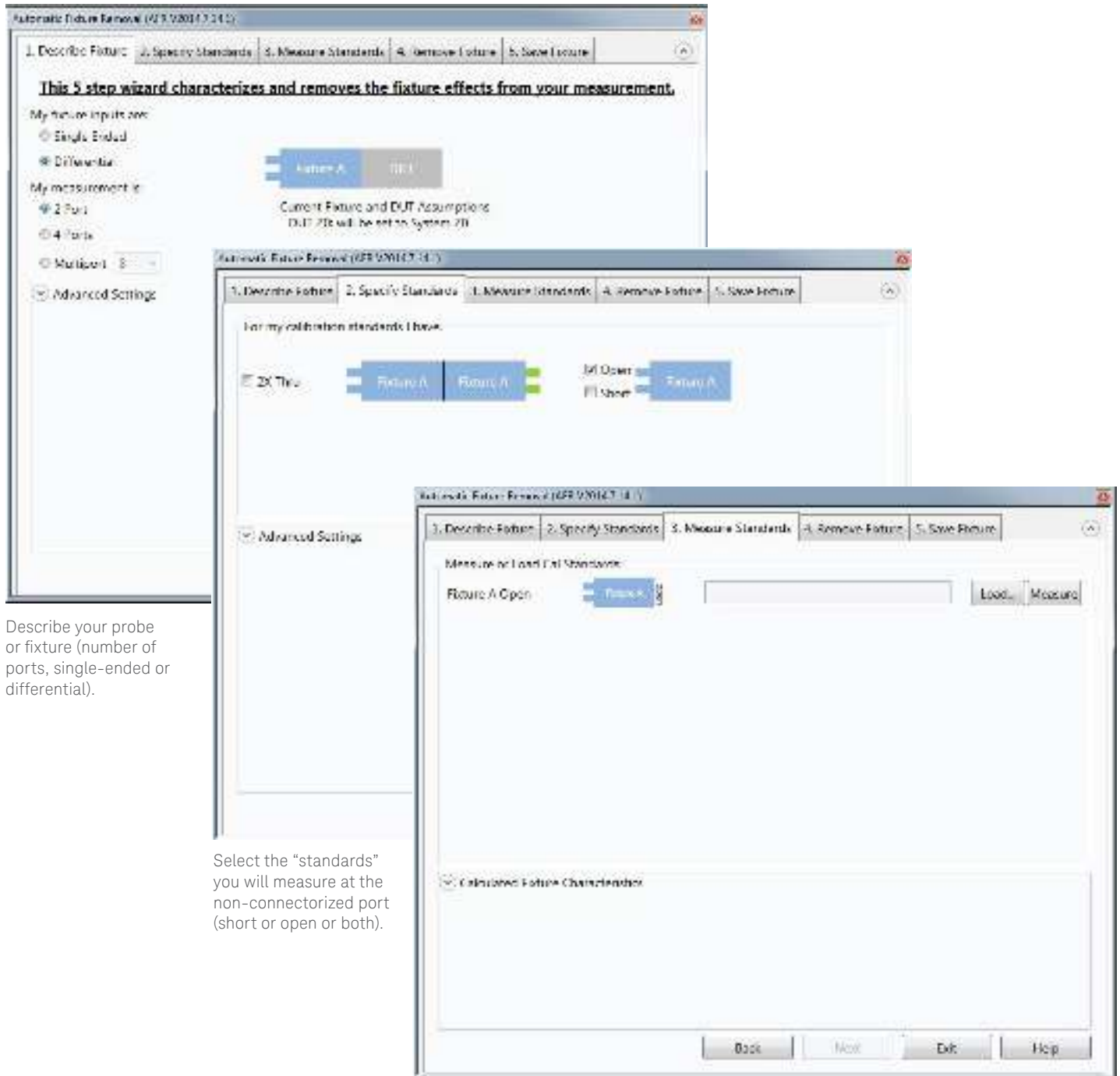

Describe your probe or fixture (number of ports, single-ended or differential).

Select the "standards" you will measure at the non-connected port (short or open or both).

Measure the probe/fixture with the non-coaxial interface terminated as described above.

## Fast and Accurate Multi-Port S-Parameters (86100D-202)

Scattering parameters (S-parameters) are generated in real-time within the oscilloscope for simultaneous display with time domain results. They are mathematically derived from TDR and TDT measurements using the 86100D Option 202 enhanced impedance and S-parameter analysis software. The N1055A's fast rise time enables calibrated S-parameter measurements to 50 GHz.

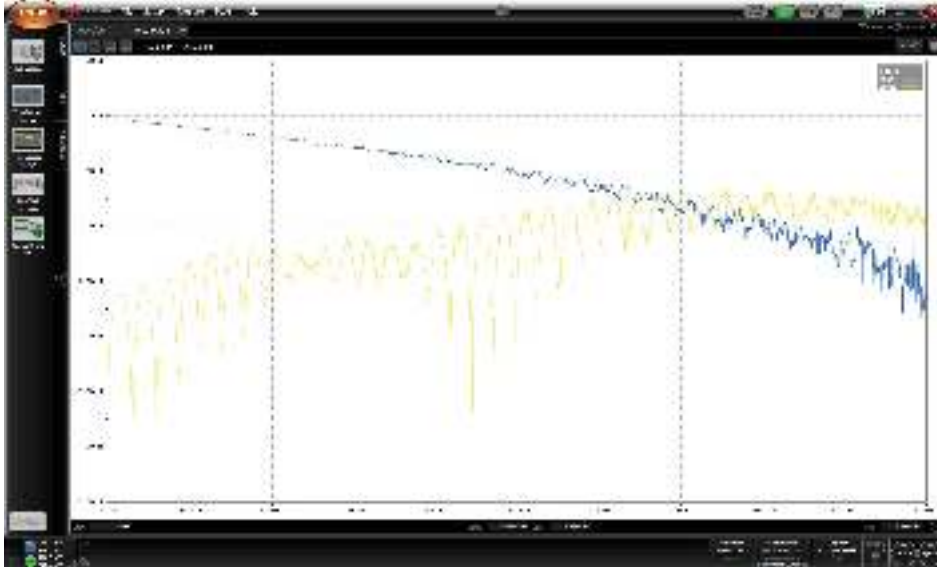

Measure and display (in real-time) calibrated S-parameters to 50 GHz.

86100D Option 202 performs single-ended and mixed-mode S-parameter measurements on up to 16 ports. The software automatically controls the sequencing of TDR steps on up to 4 ports so a full set of 4-port S-parameters can be generated by the touch of a button.

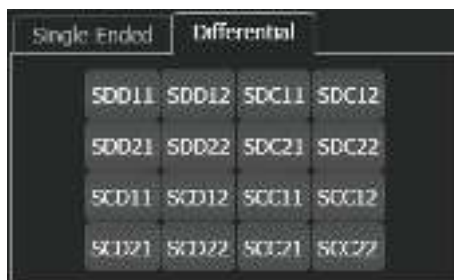

Select S-parameter measurements quickly and easily.

## Fast and Accurate Multi-Port S-Parameters (86100D-202) (Continued)

Magnitude, phase and group delay plots can be configured at the touch of a button.

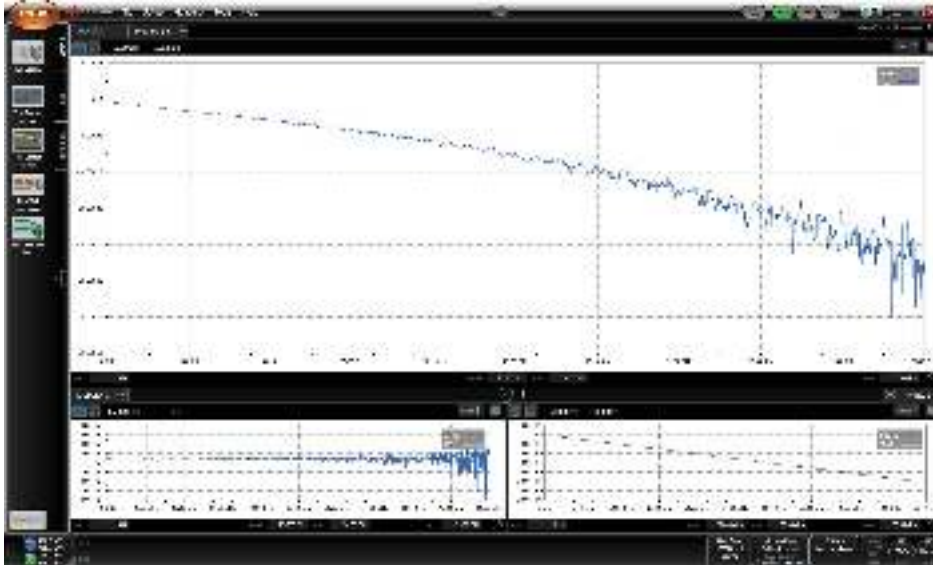

FlexDCA displays accurate S-parameter magnitude, phase and group delay plots simultaneously.

### Minimize re-connections, maximize productivity

With up to 16 TDR/TDT channels, the DCA-TDR solution also helps to minimize cable re-connections and facilitate more efficient near end crosstalk (NEXT) and far end crosstalk (FEXT) measurements both in R&D as well as high-volume test applications. For example, a 16-port system can measure NEXT and FEXT on up to four differential lanes simultaneously.



Perform efficient near-end crosstalk (NEXT) and far-end crosstalk (FEXT) measurements on differential designs that have up to four lanes.

## World's Easiest-to-Use Solution on Devices That Have up to 16 Ports

The 86100D-based system combines its powerful FlexDCA graphical user interface with the world's only TDR/TDT solution that leverages accurate, easy-to-use electronic calibration (ECal) technology. This combination provides calibrated impedance and S-parameter results that are displayed in real-time within the FlexDCA user interface—no external application, monitor or computer is required.

### True SOLT TDR Calibration

For users who do not need precision measurements and prefer to perform simple, quick impedance and S-parameter measurements on a device, a TDR/TDT calibration is not required thanks to the high-fidelity performance of the raw hardware.



A built-in wizard supports calibration methods using mechanical and electronic calibration standards.

Traditional mechanical short-open-load-thru (SOLT) calibration standards are supported, but a significant breakthrough is achieved through the support of electronic calibration (ECal) modules, an advanced calibration technique originally developed for the “gold standard” in S-parameter measurements, the vector network analyzer (VNA). A special Keysight N4694A DC-67 GHz ECal module was developed for the DCA-TDR that enables fast and accurate calibration and de-skew of TDR modules.



N4694A DC-67 GHz electronic calibration (ECal) modules make TDR calibration and de-skew fast and easy.

## Easy set-up using graphical user interface

A graphical user interface makes it easy to configure the instrument. Port names may also be customized using meaningful names that relate to the device being tested (Example: TX1+, TX1- or J1+, J1-). FlexDCA uses the custom names when displaying signals and saving waveforms.

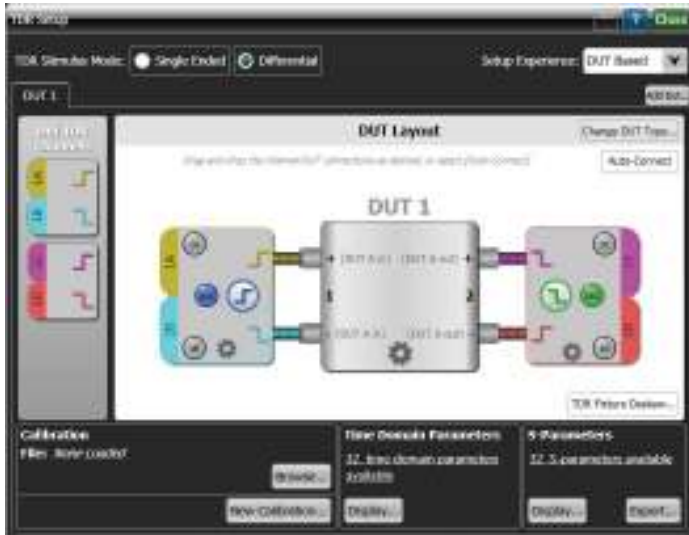

Configure the setup and customize connector/port names using the graphical user interface.

## Customizable displays

With the click of a button, FlexDCA can be configured to display impedance and S-parameter waveforms the way you want using overlapped, tiled or zoom-tiled displays.

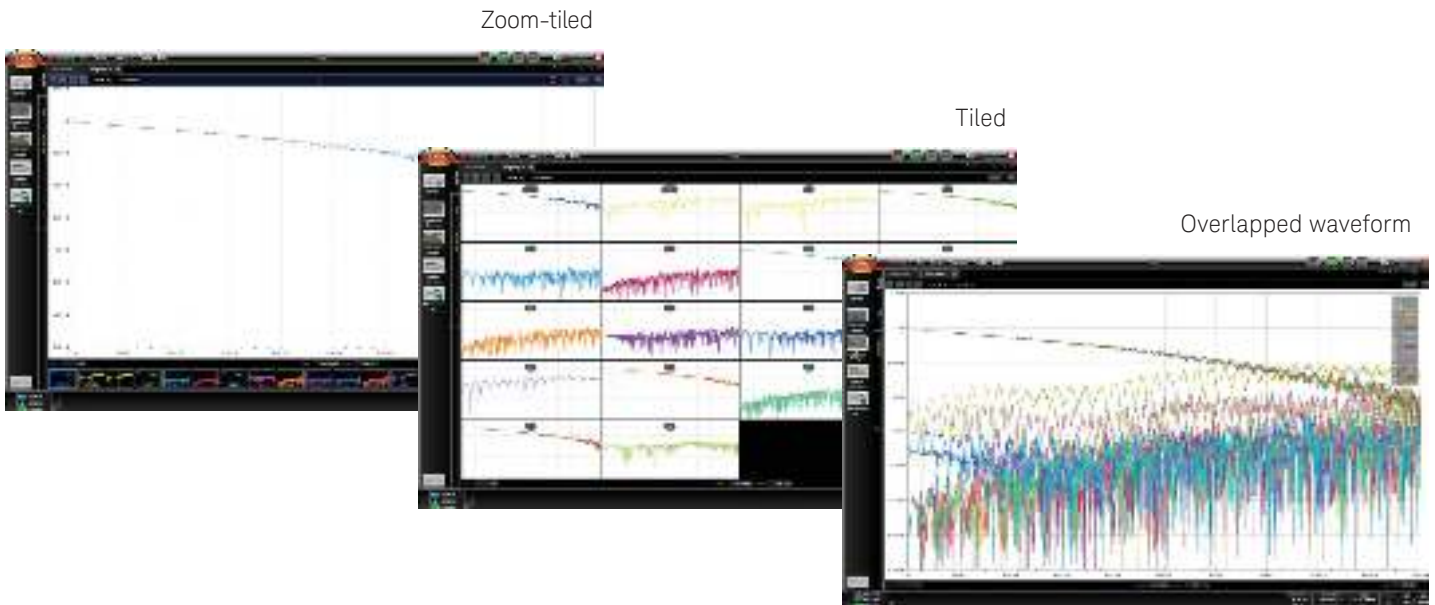

## Built-in ESD/EOS protection

Each remote head integrates a high-performance TDR step generator and high-bandwidth sampling into a microcircuit located behind the connector. To protect these high-performance components against electrostatic discharge (ESD) and electrical overstress (EOS), each microcircuit also integrates multiple 67-GHz diode limiters into the design. While the user must still follow safe ESD and EOS practices, the diode limiters offer additional protection and help protect your investment.



A high-speed step generator, sampler, and diode limiter are integrated into a proprietary microcircuit design housed in the remote head.

## N1055A receiver-only operation

The N1055A TDR/TDT module, equipped with 16 bit low-noise samplers, can also be used as a receiver only and perform accurate oscilloscope, eye/mask and jitter/noise (86100D-200/300) measurements. When used with the 86107A or 86100D-PTB precision timebase circuits, the N1055A provides a high-bandwidth measurement system with < 100 fs rms intrinsic random jitter.



The N1055A remote head modules also perform high-performance oscilloscope, eye/mask, and jitter/noise measurements.

## Easy channel and eye diagram simulations (86100D Option SIM)

Generate waveform and eye diagram simulations without using an external pattern generator. 86100D Option SIM provides integrated embedding and de-embedding channel simulations using S-parameters generated using the DCA (or imported from other tools).



FlexDCA may be used to generate waveform and eye diagram simulations using S-parameters generated by the TDR/TDT system.

## One application, FlexDCA, provides comprehensive measurement capability

FlexDCA software integrates:

- Impedance (TDR/TDT)
- S-parameter (86100D-202)
- Keysight PLTS automatic fixture removal in TDR/TDR mode (86100D-BFP)
- Oscilloscope
- Eye/mask
- Jitter/noise (Option 200/300)
- Equalization (Option 201)
- Channel simulation (Option SIM)
- Other powerful features into a single application that runs on the 86100D mainframe or on a PC (using N1010A FlexDCA)

The N1055A module is supported by all 86100D DCA-X DCA modes of operation. For more information, refer to: [www.keysight.com/find/flexdca](http://www.keysight.com/find/flexdca)

## Specifications Table

Dual/quad electrical channel modules				
Channel options (Number of channels; F = female; M = male)	32F/32M <sup>1,3</sup>	34F/34M <sup>1,3</sup>	52F/52M <sup>1,3</sup>	54F/54M <sup>1,3</sup>
Number of channels <sup>2</sup>	2	4	2	4
Electrical channel bandwidth	35 GHz <sup>4,5</sup>		35/50 GHz <sup>5</sup>	
Transition time (10 to 90% calculated from TR = 0.35/BW)	10 ps		10/7 ps	
Channel-to-channel skew range	150 ps			
RMS noise				
Characteristic	600 $\mu$ V		600/750 $\mu$ V	
Maximum	730 $\mu$ V		950 $\mu$ V	
Scale factor (per division)				
Minimum	1 mV/division			
Maximum	100 mV/division			
DC accuracy (single marker)	$\pm 2$ mV $\pm 4\%$ of (reading-channel offset)			
DC offset range (referenced from center of screen)	$\pm 500$ mV			
Input dynamic range (relative to channel offset)	$\pm 400$ mV			
Maximum input signal	+2 V/-1 V			
Nominal impedance	50 $\Omega$			
Electrical input (female or male option) <sup>3</sup>	2.92 mm		1.85 mm	
TDR step repetition rate (characteristic) <sup>6</sup>				
Mainframe timebase	1 to 250 kHz			
Module timebase - standard	1 to 80 kHz			
Module timebase - FS1	1 to 250 kHz			
Sample rate, module time base (characteristic) <sup>6</sup>				
Standard	80 kSa/s			
FS1	250 kSa/s			
Step rise/fall time (transmitted) <sup>7</sup>				
Without TDR calibration	< 18 ps		< 7 ps	
With TDR calibration	Adjustable from 15 ps, characteristic		Adjustable from 6 ps, characteristic	

1. Module is supported by 86100D DCA-X mainframe and later.

2. Upgradable from 2 channel to 4 channel after purchase (return to Keysight).

3. Connector style is the same on all channels and is selected at time of order.

4. Upgradable from 35 to 50 GHz after purchase (return to Keysight).

5. Tuned to be -3 dB ( $\pm$  measurement uncertainty) at stated bandwidth(s) using NIST traceable swept-sine test system.

6. Flex DCA software auto-selects the mainframe or module timebase based on DUT setup.

7. Defined as the transition time at the output of the remote head. It is calculated by deconvolving the receiver transition time from the measured transition time when the remote head is terminated with a short. Measured on a negative TDR step.

## Ordering Options

### N1055A 35/50 GHz 2/4 port TDR/TDT remote head

Choose ONE option:

N1055A-32F	35 GHz, 2 channel, 2.92 mm, female
N1055A-32M	35 GHz, 2 channel, 2.92 mm, male
N1055A-34F	35 GHz, 4 channel, 2.92 mm, female
N1055A-34M	35 GHz, 4 channel, 2.92 mm, male
N1055A-52F	50 GHz, 2 channel, 1.85 mm, female
N1055A-52M	50 GHz, 2 channel, 1.85 mm, male
N1055A-54F	50 GHz, 4 channel, 1.85 mm, female
N1055A-54M	50 GHz, 4 channel, 1.85 mm, male



N1055A-FS1	Fast sampling
------------	---------------

#### N1055A included accessories

N1027A-1CL	Cable management clips (6 at yellow, pink, blue, green)
N1027A-2CL	2 remote head clips
8710-1765	Torque wrench 8 lb-in, 5/16 in
85138-60002	1.85 mm load, male for each 50 GHz channel with female connector
85138-60001	1.85 mm load, female for each 50 GHz channel with male connector
00902-60003	3.5 mm load, male for each 35 GHz channel with female connector
00902-60004	3.5 mm load, female for each 35 GHz channel with male connector

#### N1055A optional accessories

N1027A-3MC	Storage case for N1055A module
N1027A-3AC	Accessory case for N1055A module
N1027A-1C1	Coaxial cable 1.85 mm, M/M, 67 GHz, 10 cm

### Multiple module configurations require 86100D-ETR

86100D-ETR is required if more than one module in the DCA will be connected to the same DUT. For example if using two 2-channel modules to perform TDR/TDT on one DUT.

### Calibration kits

Electronic Calibration (ECal) modules

Note that for TDR applications, ECal modules must have no DC blocks and must be characterized to DC. Most of the ECal modules in use today for VNA applications do not meet these requirements and are not suitable for use with TDR. The following ECal modules are the only ECal modules available that meet the requirements for TDR applications:

N4694A-HMM	ECal module, DC-67 GHz, 1.85 mm, male-male
N4694A-HFF	ECal module, DC-67 GHz, 1.85 mm, female-female
N4694A-HMF	ECal module, DC-67 GHz, 1.85 mm, male-female



Mechanical calibration kits supported by the 86100D

Note that some of the below mechanical calibration kits are no longer available. However, if you already have one, you can use it with your 86100D TDR.

85033D	3.5 mm calibration kit, 30 kHz to 6 GHz
85033E	Standard mechanical calibration kit, DC to 9 GHz, 3.5 mm
85052B	Standard mechanical calibration kit, DC to 26.5 GHz, 3.5 mm
85052C	Precision mechanical calibration kit, DC to 26.5 GHz, 3.5 mm
85052D	Economy mechanical calibration kit, DC to 26.5 GHz, 3.5 mm
85056A	Standard mechanical calibration kit, DC to 50 GHz, 2.4 mm
85056D	Economy mechanical calibration kit, DC to 50 GHz, 2.4 mm
85056KE01 or KE02	Calibration kit, DC to 40 GHz, 2.92 mm
85058B	Standard mechanical calibration kit, DC to 67 GHz, 1.85 mm
85058E	Economy mechanical calibration kit, DC to 67 GHz, 1.85 mm
N1024A or N1024B	20 GHz SLT TDR calibration kit

[www.keysight.com/find/N1055A](http://www.keysight.com/find/N1055A)



This information is subject to change without notice.  
© Keysight Technologies, 2015 - 2017  
Published in USA, December 5, 2017  
5991-3813EN  
[www.keysight.com](http://www.keysight.com)